

PRODUCTION SPECIFICATION

MODEL: W101P50H2RI-J05H0-370

CUSTOMER:
APPROVED BY:
DATE:

DESIGNED	CHECKED	APPROVED



REVISION STATUS

Revision	Description	Page	Revision Date
1.0	First Revision	--	2016-07-05

Contents	Page
1.0. General Specification	4
2.0. Absolute Maximum Ratings	5
3.0. Optical characteristics	6
4.0. Block Diagram	10
5.0. Interface pin connection	11
6.0. Electrical characteristics	13
7.0. Reliability test items	19
8.0. Outline dimension	20
9.0. Lot mark	22
10.0. Package specification	23
11.0. General Precaution	24

1.0 GENERAL DESCRIPTION

1.1 Introduction

The model W101P50H2RI-J05H0-370 is a color active matrix thin film transistor (TFT) liquid crystal display without plagiarizer. This model is composed of amorphous silicon TFT as a switching device. This TFT LCD has a 10.1-inch wide (16:9) diagonally measured active display area with WVGA (1024 horizontal by 600 vertical pixel) resolution. Each pixel is divided into Red, Green, Blue dots which are arranged in vertical stripes.

1.2 Features

- 10.1 inch configuration.
- One channel LVDS interface
- 16.7M color by 8 bit R.G.B. signal input
- RoHS/Halogen Free Compliance

1.3 Applications

- Mobile NB
- Digital Photo frame
- Display terminal for AV application

1.4 General information

Item	Specification	Unit
Screen Size	10.1 inches	Diagonal
Number of Pixel	1024 RGB (H) ×600(V)	Pixels
Display area	222.72(H) x 125.28(V)	mm
Outline Dimension	235.0 x 143.0 x 5.0(Typ)	mm
Display mode	Normally Black	--
Pixel arrangement	RGB Vertical stripe	--
Pixel pitch	0.2175(H) ×0.2088(V)	mm
Back-light	LED Side-light type	--
Surface treatment	Anti - glare	--
Interface	TTL	

1.5 Mechanical Information

Item		Min.	Typ.	Max.	Unit
Module Size	Horizontal (H)	234.7	235.0	235.3	mm
	Vertical (V)	142.7	143.0	143.3	mm
	Depth (D)	4.7	5.0	5.3	mm
Weight		--	300	320	g

2.0 ABSOLUTE MAXIMUM RATINGS

2.1 Electrical Absolute Rating

2.1.1 TFT LCD Module

Item	Symbol	Min	Max	Unit	Note
Power supply voltage	VDD	-0.5	3.96	V	GND=0
	AVDD	--	14.85	V	AGND=0

Note:

1. Stresses above those listed under "Absolute Maximum Rating" may cause permanent damage to the device. These are stress ratings only. Functional operation of this device at indicated in the operational sections(6.1) of this specification.

2. $T_a=25\pm 2^{\circ}\text{C}$

2.2 Environment Absolute Rating

Item	Symbol	Min.	Max.	Unit	Note
Storage temperature	T_{STG}	-30	80	$^{\circ}\text{C}$	
Operating temperature	T_{OPR}	-20	70	$^{\circ}\text{C}$	

Note: If users use the product out off the environmental operation range(temperature and humidity), it will have visual quality concerns.

3.0 OPTICAL CHARACTERISTICS

3.1 Optical specification

Item	Symbol	Condition	Min	Type	Max	Unit	Note
White luminance (Center)	YL	θ=0 Normal Viewing Angle	330	370		TBD nits	(1)(4)(6)
Response time	T _r		--	10	20	msec	(1)(3)
	T _f		--	20	25		
Contrast ratio	CR		600	800	--	--	(1)(2)
Color Chromaticity (CIE 1931)	white W _x		0.260	0.310	0.360		(1)(4)
	W _y		0.280	0.330	0.380		
Viewing Angle	Hor.	θ _L	80	85	--		(1)(4)
		θ _R	80	85	--		
	Ver.	θ _U	80	85	--		
		θ _D	80	85	--		
Brightness	B _{UNI}	θ=0	80	--	--	%	(5)
Color gamut (NTSC)	S		--	45	--	%	
Optima View Direction	ALL VIEW						

1), 客户签样亮度±10% = 大货亮度,小于10%视为不良。

2), 大货同一批色调一致的情况下(目视同为冷色或暖色)与客户签样相比, X色坐标相差±0.015, Y色坐标相差±0.02以内视为正常OK品。

3.2 Measuring Condition

- „ Measuring surrounding: dark room
- „ LED current IL: 250mA
- „ Ambient temperature: 25±2°C
- „ 30min. warm-up time

3.3 Measuring Equipment

- „ BM-7 optical characteristics.
- „ Measuring spot size: 20 ~ 21mm

Note (1) Definition of Viewing Angle

Viewing angle is the angle at which the contrast ratio is greater than 10. The viewing angles are determined for the horizontal or 3, 9 o'clock direction and the vertical or 6, 12 o'clock direction with respect to the optical axis which is normal to the LCD surface (see FIGURE 1).

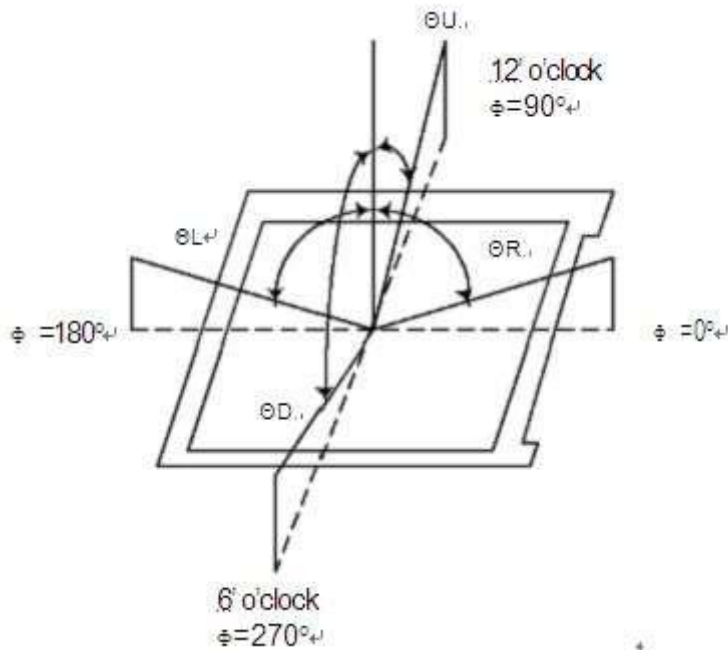

Note (2) Definition of Contrast Ratio(CR):
Measured at the center point of panel

$$CR = \frac{\text{Luminance with all pixels white}}{\text{Luminance with all pixels black}}$$

Note (3) Definition of Response Time: Sum of TR and TF

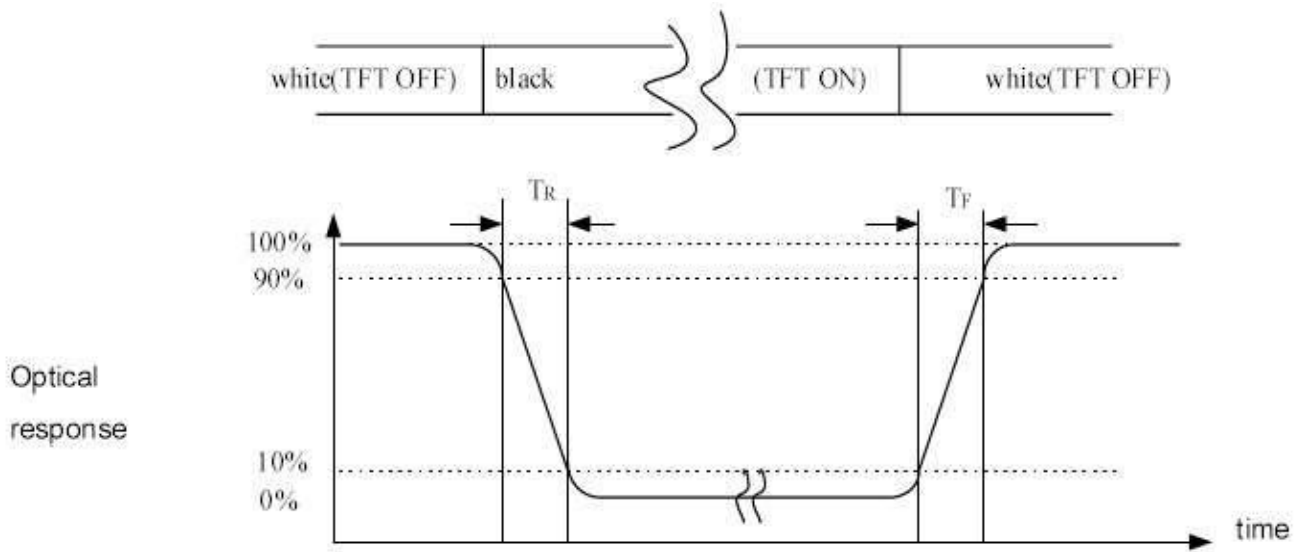

Note (4) Definition of optical measurement setup

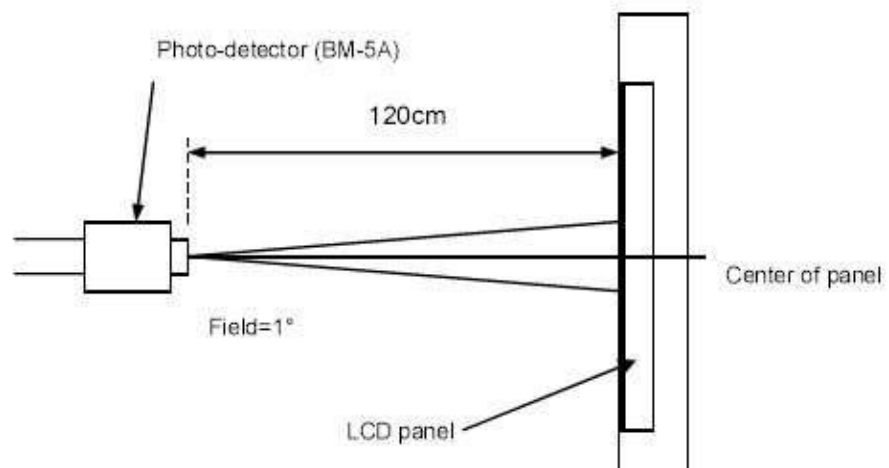

Note (5) Definition of brightness uniformity



$$\text{Luminance uniformity} = \frac{\text{(Min Luminance of 9 points)}}{\text{(Max Luminance of 9 points)}} \times 100 \%$$

Note (6) Rubbing Direction (The different Rubbing Direction will cause the different optima view direction.

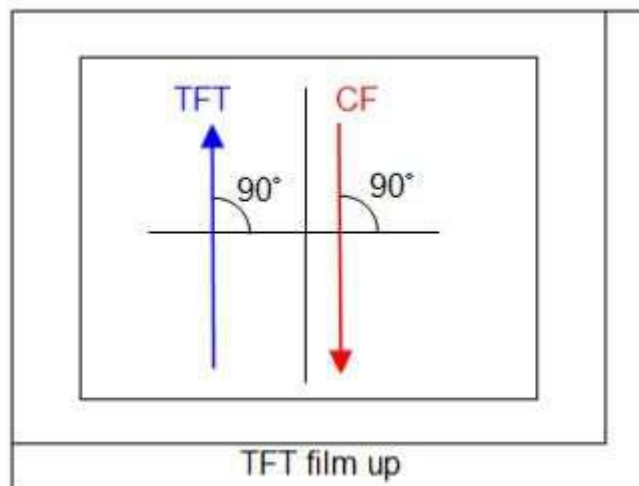

4.0 BLOCK DIAGRAM

4.1 TFT LCD Module

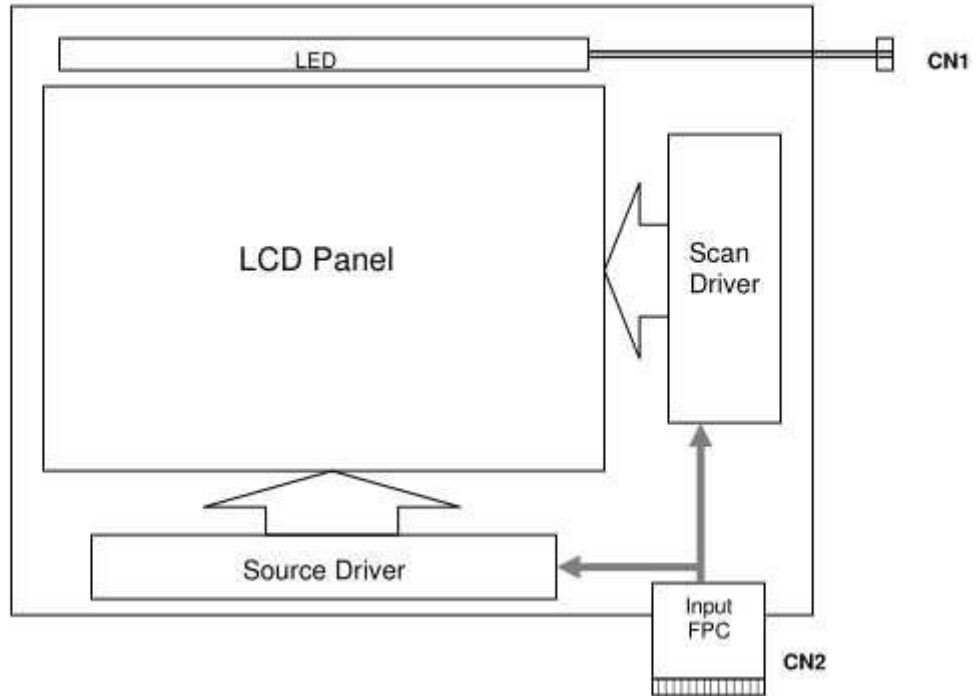

4.2 Pixel Format

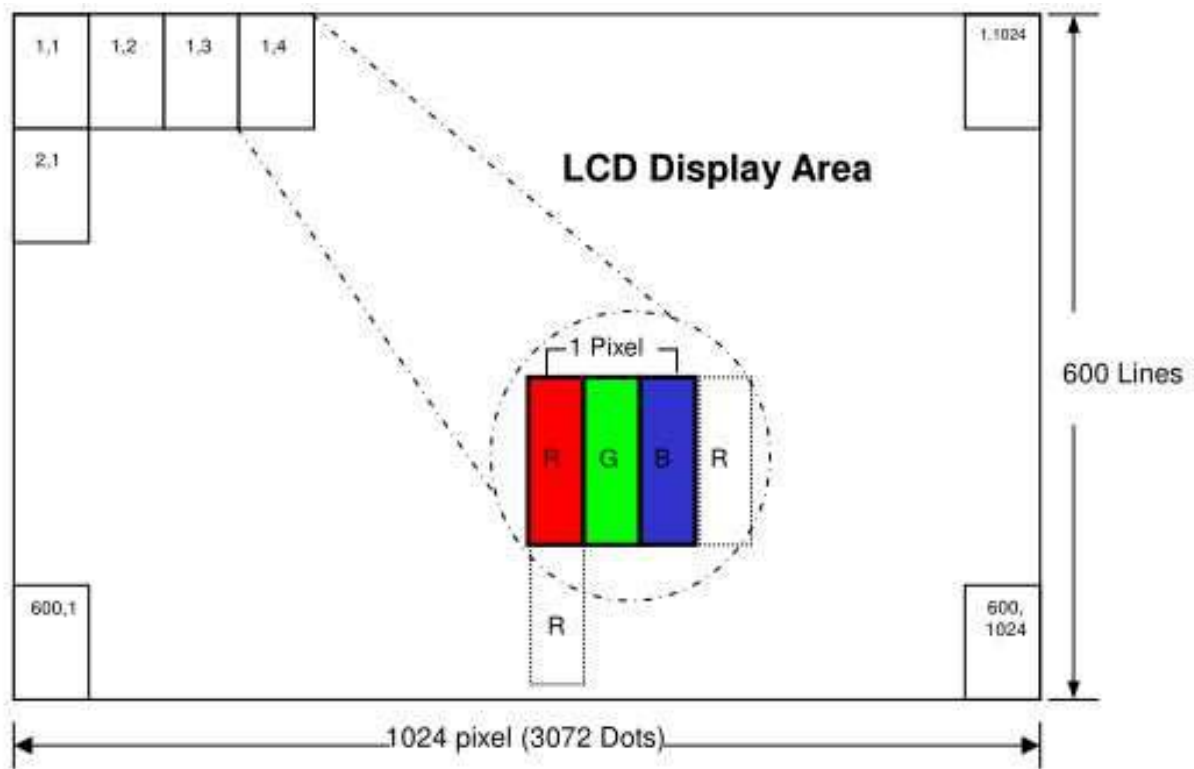

5.0 INTERFACE PIN CONNECTION

5.1 TFT LCD Module: FPC Down Connector, (FH28-50S-0.5SH (HIROSE), 50pin,pitch = 0.5mm)

Pin No.	Symbol	Function	Reamrk
1	LED+	Power for LED back-light(Anode)	
2	LED+	Power for LED back-light(Anode)	
3	LED-	Power for LED back-light(Cathode)	
4	LED-	Power for LED back-light(Cathode)	
5	GND	Power Ground	
6	VCOM	Common Voltage	
7	VDD	Digital Power	
8	MODE	DE/SYNC Mode Select. Normally Pull High H :DE mode. L :HSD/VSD mode	
9	DEN	Date Enable signal	
10	VSYNC	Vertical sync input. Negative polarity	
11	HSYNC	Horizontal sync input. Negative polarity	
12	B7	Blue Data Input(MSB)	
13	B6	Blue Data Input	
14	B5	Blue Data Input	
15	B4	Blue Data Input	
16	B3	Blue Data Input	
17	B2	Blue Data Input	
18	B1	Blue Data Input	
19	B0	Blue Data Input(LSB)	
20	G7	Green Data Input(MSB)	
21	G6	Green Data Input	
22	G5	Green Data Input	
23	G4	Green Data Input	
24	G3	Green Data Input	
25	G2	Green Data Input	
26	G1	Green Data Input	
27	G0	Green Data Input(LSB)	
28	R7	Red Data Input(MSB)	
29	R6	Red Data Input	
30	R5	Red Data Input	
31	R4	Red Data Input	
32	R3	Red Data Input	
33	R2	Red Data Input	
34	R1	Red Data Input	
35	R0	Red Data Input(LSB)	

Pin No.	Symbol	Function	Reamrk
36	GND	Power Ground	
37	DCLK	Clock Input	
38	GND	Power Ground	
39	SHLR	Left or Right Display Control	
40	UPDN	Up/Down Display Control	
41	VGH	Positive Power for TFT	
42	VGL	Negative Power for TFT	
43	AVDD	Analog Power	
44	RSTB	Global reset pin. Active low to enter reset state. Suggest to connecting with an RC reset circuit for stability. Normally pull high($R=10K \Omega$ $C=1 \mu F$)	
45	NC	Not Connect	
46	VCOM	External VCOM DC input	
47	DITHB	Dithering setting. DITH="H" Disable internal dithering function DITH="L" Enable internal dithering function	
48	GND	Power Ground	
49	NC	Not Connect	
50	NC	Not Connect	

Note 1: SHLR: left or right setting

UPDN: up or down setting

SHLR	UPDN	Data Shifting
DVDD	GND	Left→Right, Up→Down(Default)
GND	GND	Right→Left, Up→Down
DVDD	DVDD	Left→right, Down→Up
GND	DVDD	Right→Left, Down→Up

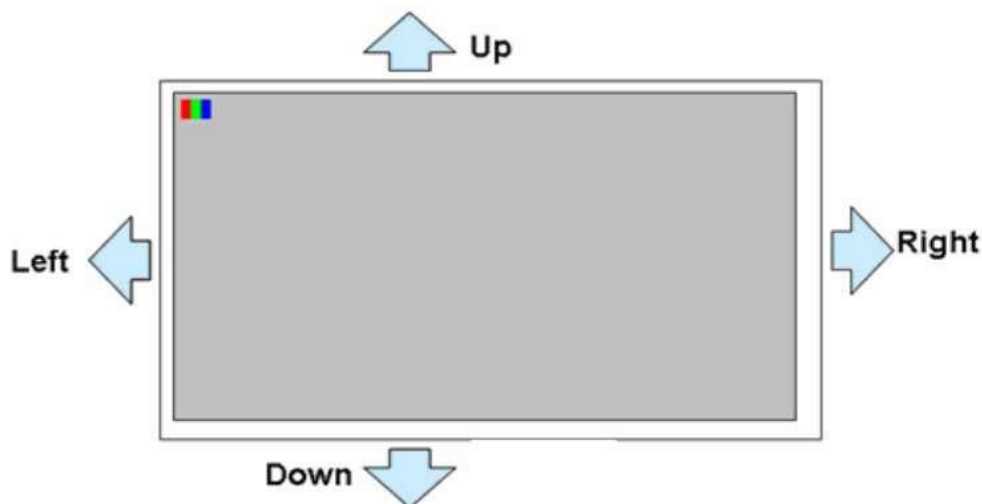

5.2 Back-Light Unit

The backlight system is an edge-lighting type with 36 LED.

The characteristics of the LED are shown in the following tables.

Item	Symbol	Min	Typ	Max	Unit	Note
LED current	IL	240	250	--	mA	
LED voltage	VL	9.6	10.5	--	V	
Operating LED life time	Hr	--	20000	--	Hour	(1)

Note (1) LED life time (Hr) can be defined as the time in which it continues to operate under the condition: $T_a=25\pm 3\text{ }^\circ\text{C}$, typical IL value indicated in the above table and the $f_L=50\text{k}$ Hz until the brightness becomes less than 50%.

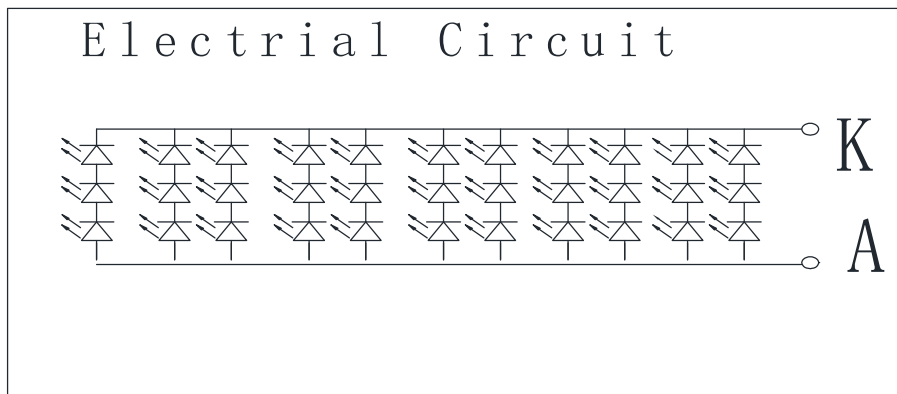

3串9并 27灯

6.1 TFT LCD Module

Item	Symbol	Min.	Typ.	Max.	Unit	Note
Power Supply Voltage	VDD	3.0	3.3	3.6	V	
Analog Power Supply Voltage	AVDD	10.0	10.2	10.5	V	调整对比度，调大颜色变深，调小颜色变浅
Gate On Power Supply Voltage	VGH	7	20	35	V	
Gate Off Power Supply Voltage	VGL	-10.3	-10	-9.7	V	
Common Power Supply Voltage	VCOM	3.9	4.2	4.5	V	Note 1
Operation frequency	FCLK	--	--	200	KHZ	

Note 1: Please adjust VCOM to make the flicker level be minimum. Typ VCOM 电压值
只做参考，具体以实际效果为准（根据FLICKER 状态可调整）

Note (2): Be sure to apply the power Voltage as the power sequence spec.

Note (3): GND=0V

6.2 For 1024RGB x 600 panel

DE mode

DE mode					
Parameter	Symbol	Value			Unit
		Min.	Typ.	Max.	
DCLK frequency @Frame rate=60hz	fclk	40.8	51.2	67.2	Mhz
Horizontal display area	thd	1024			DCLK
HSYNC period time	th	1114	1344	1400	DCLK
HSYNC blanking	thb+thfp	90	320	376	DCLK
Vertical display area	tvd	600			H
VSYNC period time	tv	610	635	800	H
VSYNC blanking	tvb+tvfp	10	35	200	H

HV mode(1)

HV mode					
Horizontal input timing					
Parameter	Symbol	Value			Unit
Horizontal display area	thd	1024			DCLK
DCLK frequency@Frame rate=60hz	fclk	Min.	Typ.	Max.	Mhz
		44.9	51.2	63	
1 Horizontal Line	th	1200	1344	1400	DCLK
HSYNC pulse width	thpw	Min.	1		
		Typ.	-		
		Max.	140		
HSYNC back porch	thbp	160	160	160	
HSYNC front porch	thfp	16	160	216	

HV mode(2)

Vertical input timing					
Parameter	Symbol	Value			Unit
		Min.	Typ.	Max.	
Vertical display area	tvd	600			H
VSYNC period time	tv	624	635	750	H
VSYNC pulse width	tvpw	1	-	20	H
VSYNC back porch	tvb	23	23	23	H
VSYNC front porch	tvfp	1	12	127	H

6.3 AC Electrical Characteristics

(TA = -20 to 85° C, VDD = 2.3 to 3.6V, AVDD = 8 to 13.5V, GND = AGND = 0V)

TTL mode

Parameter	Symbol	Condition	Min.	Typ.	Max.	Unit
VDD Power On Slew rate	TPOR	From 0V to 90% VDD	-	-	20	ms
RSTB pulse width	TRST	DCLK = 65MHz	50	-	-	us
DCLK cycle time	Tcph	-	14	-	-	ns
DCLK pulse duty	Tcwh	-	40	50	60	%
VSD setup time	Tvst	-	5	-	-	ns
VSD hold time	Tvhd	-	5	-	-	ns
HSD setup time	Thst	-	5	-	-	ns
HSD hold time	Thhd	-	5	-	-	ns
Data set-up time	Tdsu	D0[7:0], D1[7:0], D2[7:0] to DCLK	5	-	-	ns
Data hold time	Tdhd	D0[7:0], D1[7:0], D2[7:0] to DCLK	5	-	-	ns
DE setup time	Tesu	-	5	-	-	ns
DE hold time	Tehd	-	5	-	-	ns
Output stable time	Tsst	10% to 90% target voltage, CL=90pF, R=10K ohm(Cascade)	-	-	6	us
		Dual gate	-	-	3	

Output Timing Table

Parameter	Symbol	Min.	Typ.	Max.	Unit	Condition
DCLK frequency	Fclk	-	65	71	MHz	VDD =2.3~3.6V
DCLK cycle time	Tclk	14.1	15.4	-	ns	
DCLK pulse duty	Tcwh	40	50	60	%	Tclk
Time from HSD to Source Output	Thso	-	64	-	DCLK	
Time from HSD to LD	Thld	-	64	-	DCLK	
Time from HSD to STV	Thstv	-	2	-	DCLK	
Time from HSD to CKV	Thckv	-	20	-	DCLK	
Time from HSD to OEV	Thoev	-	4	-	DCLK	
LD pulse width	Twld	-	10	-	DCLK	
CKV pulse width	Twckv	-	66	-	DCLK	
OEV pulse width	Twoev	-	74	-	DCLK	

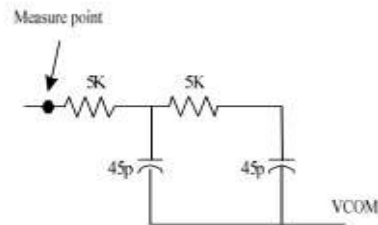
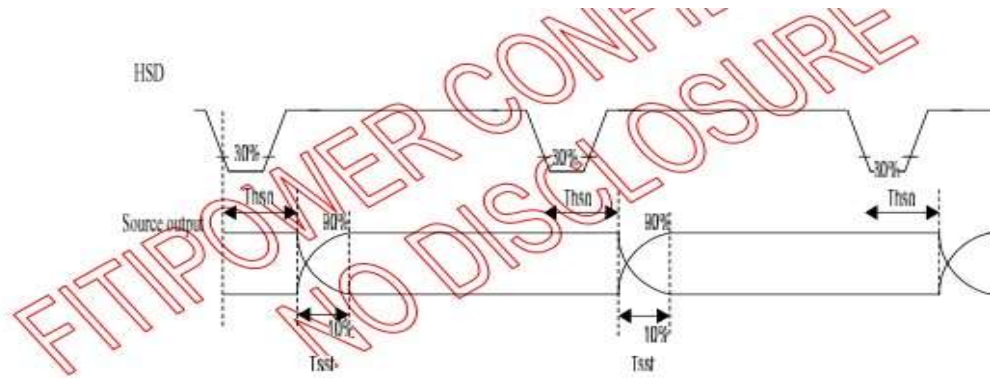

Source Output Timing(Cascade)

6.4 Timing Waveform

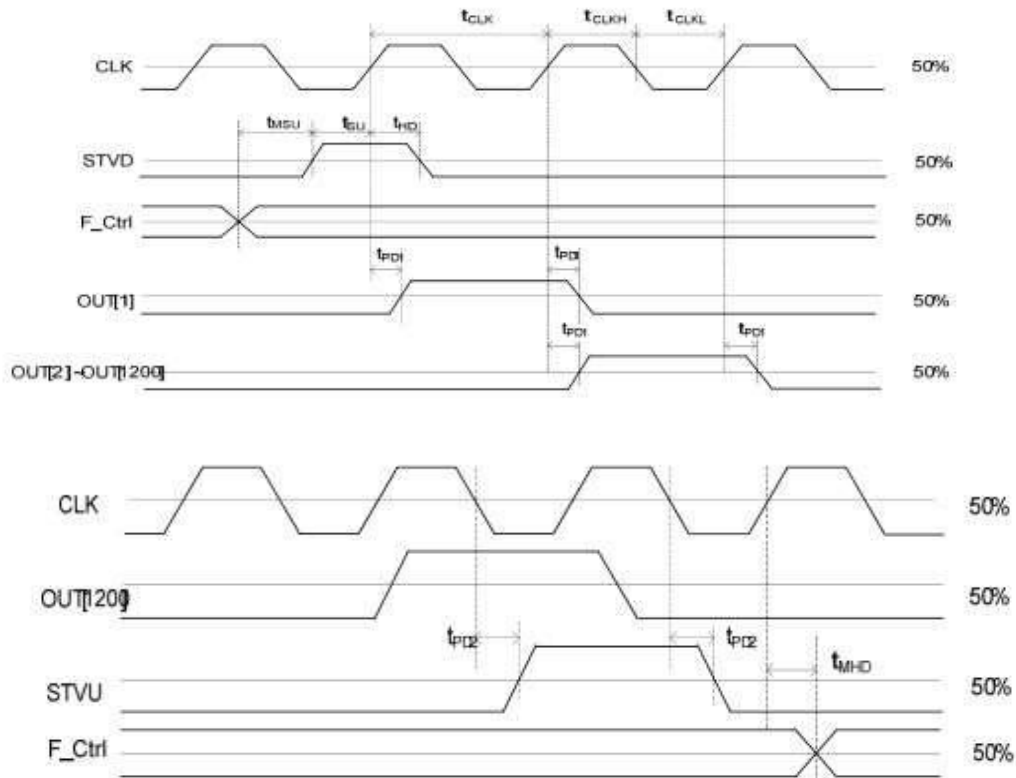

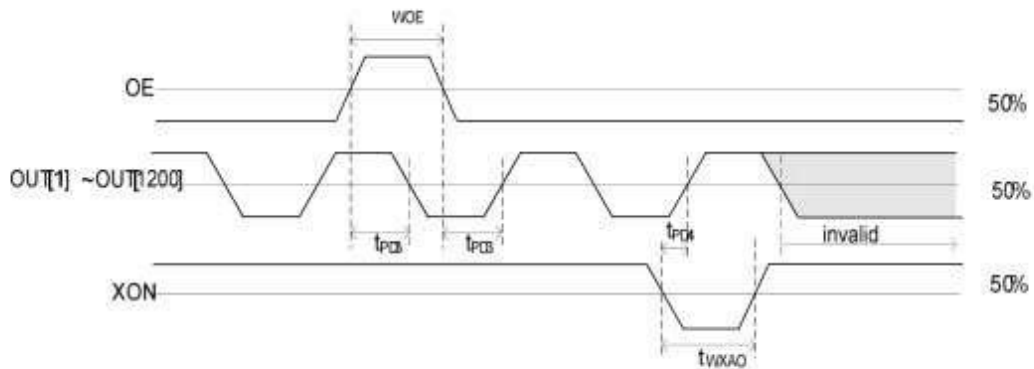

6.4.1 Data Input Format for TTL

Vertical input timing

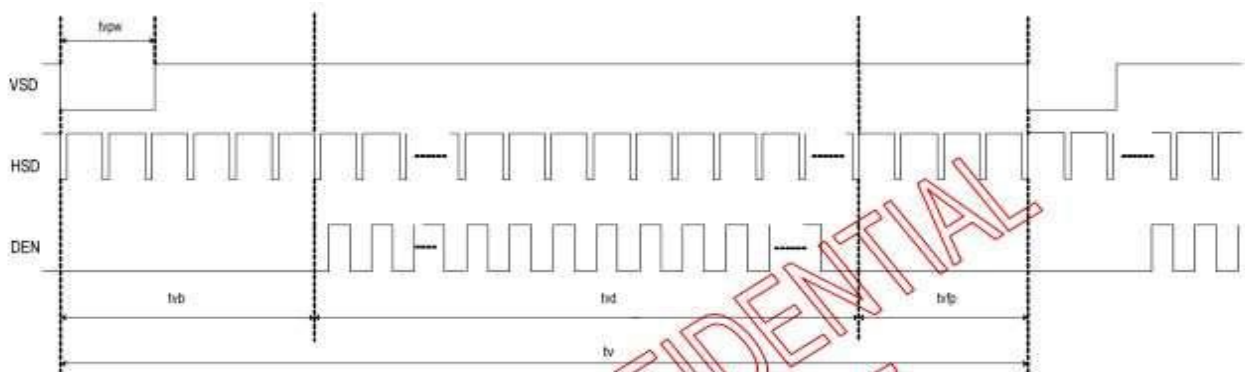

Horizontal input timing

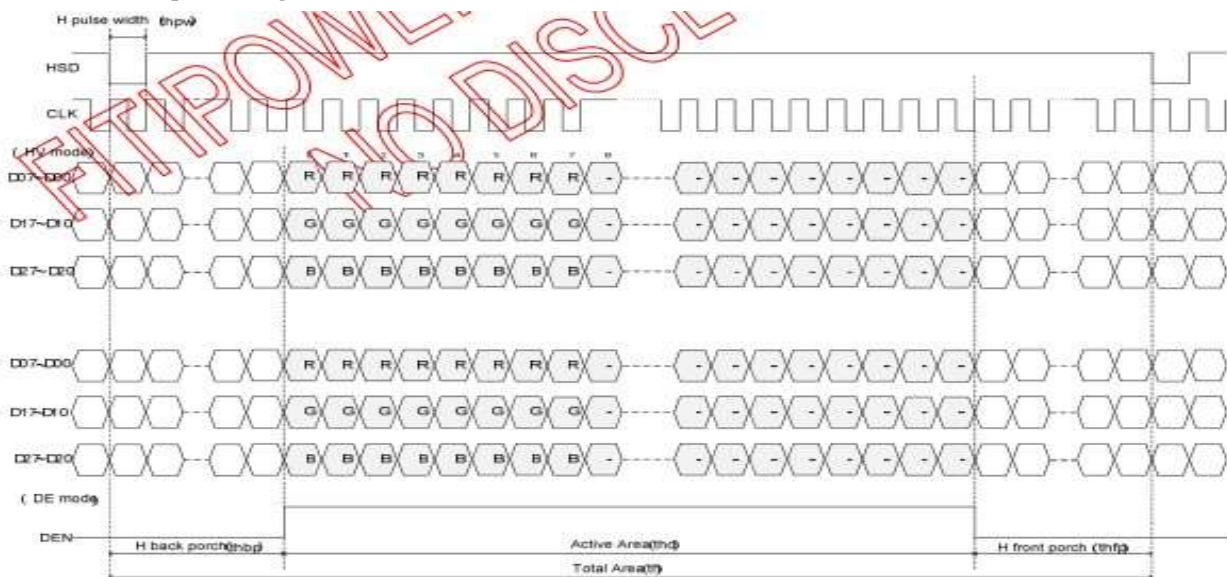

6.4.2 Vertical Timing Diagram HV mode(Cascade)

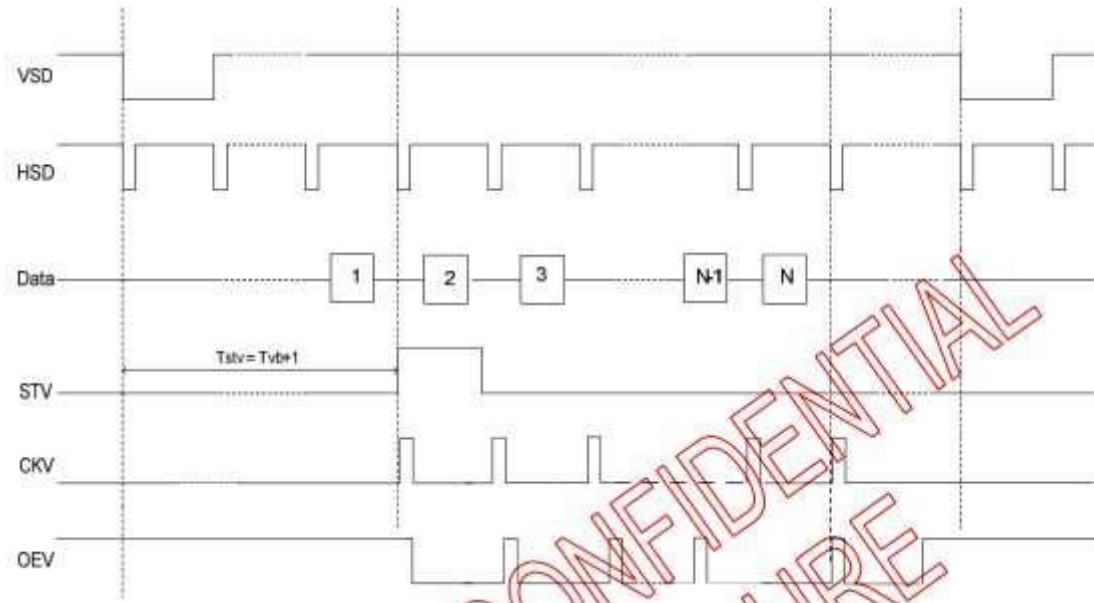

6.4.3 Vertical Timing Diagram DE mode(Cascade)

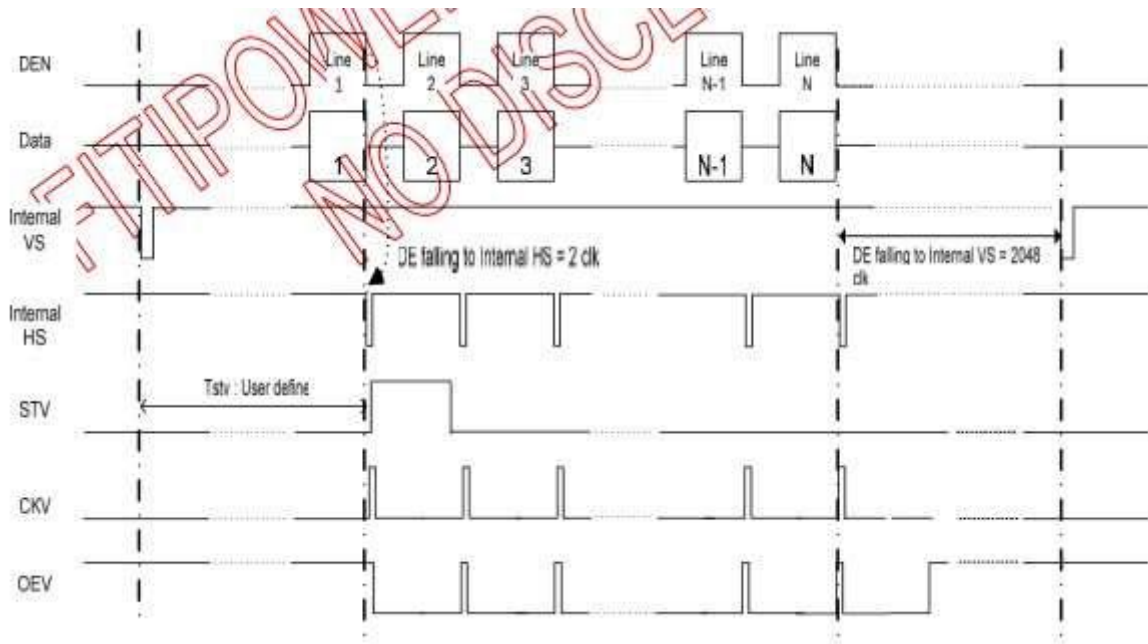

6.4.4 Gate output timing diagram(Cascade)

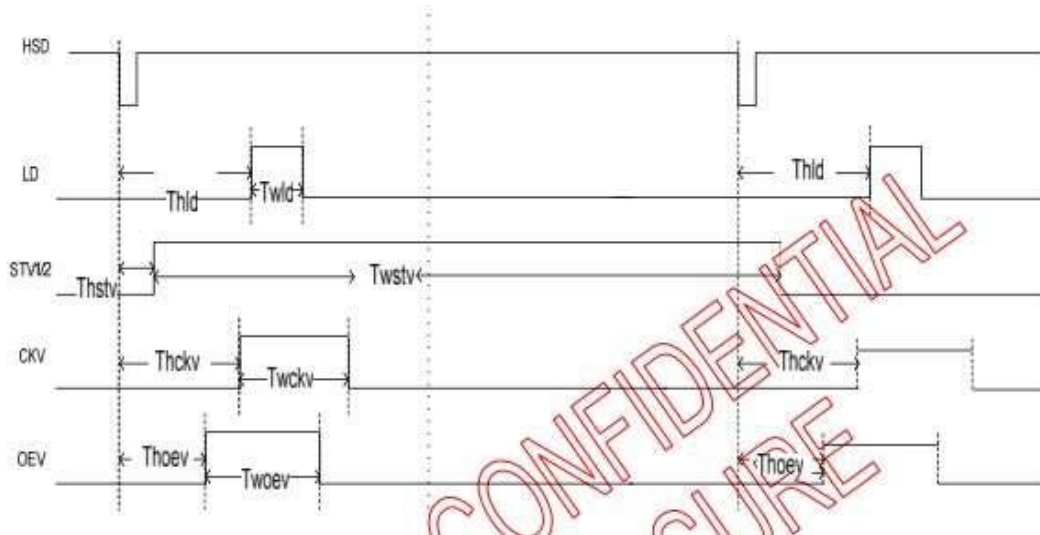

6.4.5 Vertical Timing Diagram HV mode(Dual Gate)

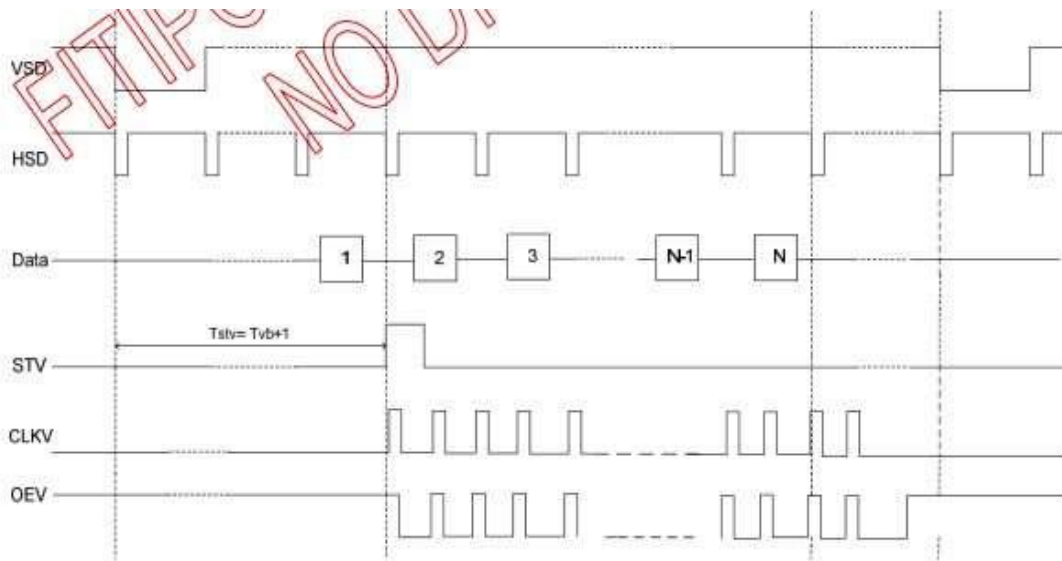

6.4.6 Vertical Timing Diagram DE mode(Dual Gate)

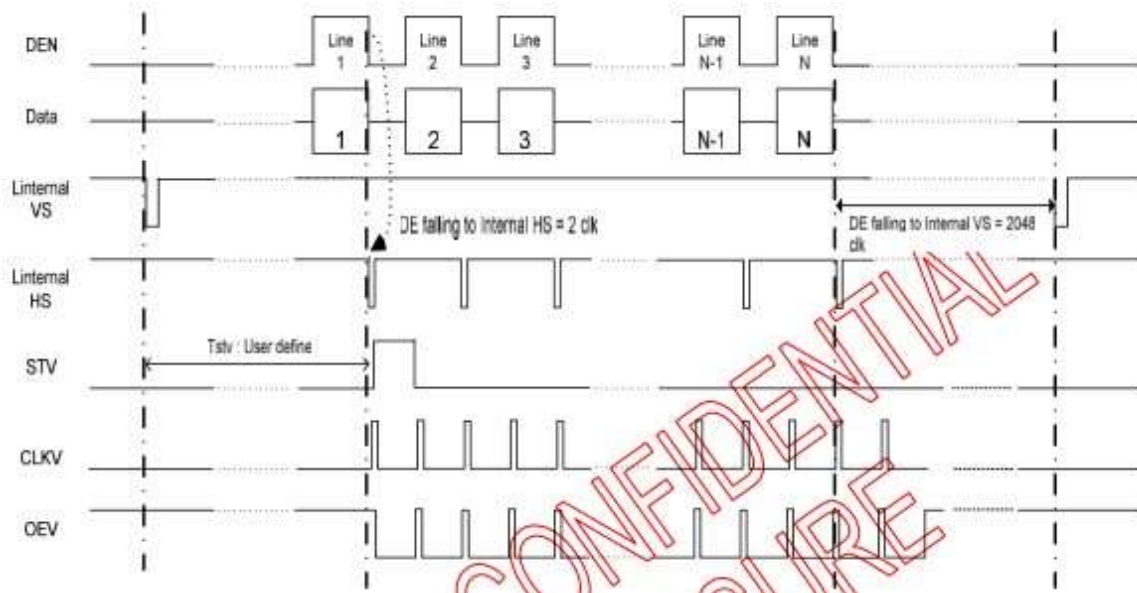

6.4.7 Gate output timing diagram(Dual Gate)

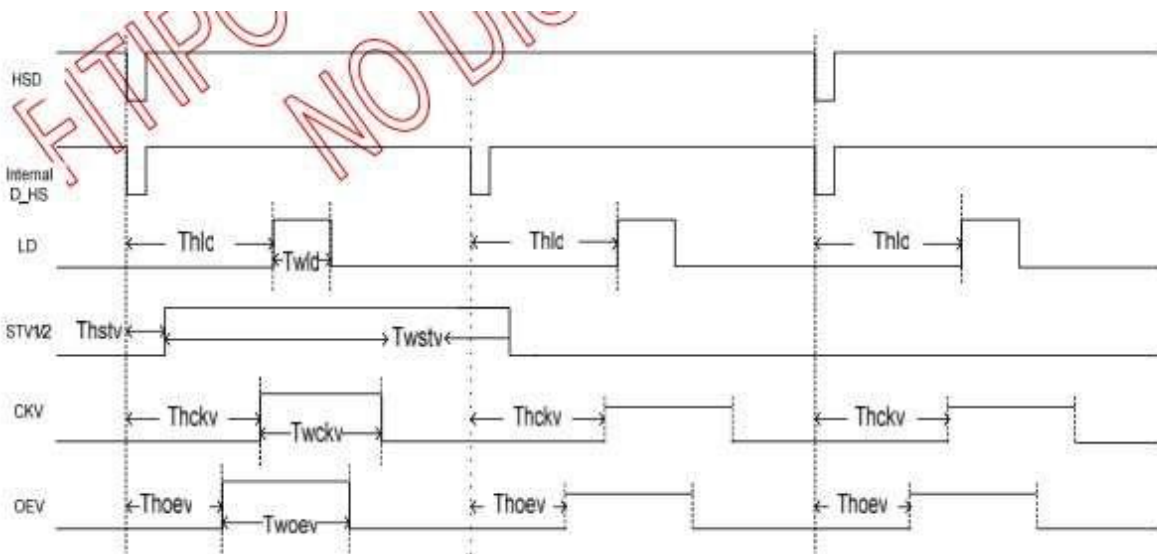

7.0 RELIABILITY TEST ITEMS

No.	Test Item	Conditions	Note
1	High Temperature Storage	Ta=+80°C, 240hrs	
2	Low Temperature Storage	Ta=-30°C, 240hrs	
3	High Temperature Operation	Ta=+70°C, 240hrs	
4	Low Temperature Operation	Ta=-20°C, 240hrs	
5	High Temperature and High Humidity(operation)	Ta=+70°C, 80%RH 240hrs	
6	Thermal cycling Test	-30°C/30 min ~ +80°C/30 min for a total 200 cycles, Start with cold temperature and end with high temperature.	
7	Vibration Test (Non-operation)	<ul style="list-style-type: none"> ● Frequency range:8~33.3Hz ● Stoke: 1.3 mm ● Vibration: sinusoidal wave, perpendicular axis(both x, z axis: 2hrs ,y axis: 4hrs). ● Sweep: 2.9G,33.3 Hz -400 Hz ● Cycle time: 15 min 	
8	Shock Test (Non-operation)	<ul style="list-style-type: none"> ● Shock level: 980m/s² (equal to 100G). ● Waveform: half sinusoidal wave,6ms. ● Number of shocks: ±X,±Y,±Z axes for a total of six shock inputs. 	
9	ESD Test	150pF, 330Ω, ±8kV&±15kV air& contact test	1
		200pF, 0Ω, ±200V contact test	2

Note 1: LCD glass and metal bezel

Note 2: IF connector pins

Note 3: Operation with test pattern sustained for 4hrs, then change to gray pattern immediately.

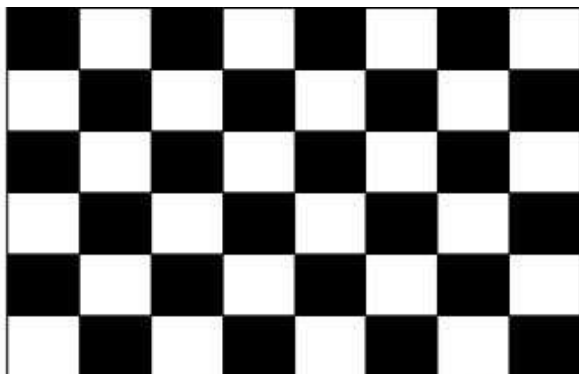

(a) Test Pattern (chess board Pattern)



(b) Gray Pattern

9.0 PACKAGE SPECIFICATION

10.1 Packing form

LCM Model	LCM Qty. in the box	Inner Box Size (mm)	Note
W101P50H2RI -J05H0-370	60 pcs/box	383±5 x 373±5 x 275±5	

10.2 Packing assembly drawings

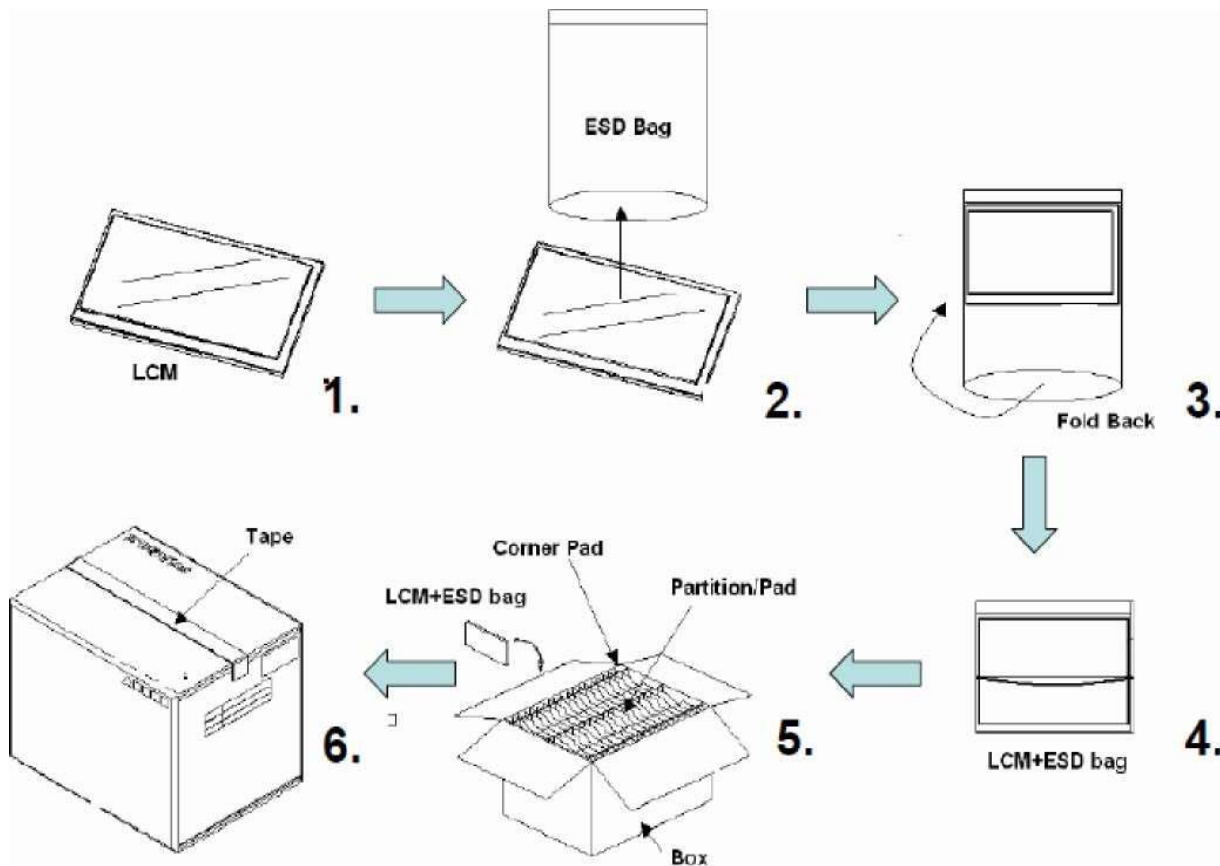

Items	Material	Notice
Box	Corrugated Paper Board	AB Flute
Partition/Pad	Corrugated Paper Board	B Flute
Corner Pad	Corrugated Paper Board	AB Flute
ESD bag	PE	

11.0 GENERAL PRECAUTION

11.1 Use Restriction

This product is not authorized for use in life supporting systems, aircraft navigation control systems, military systems and any other application where performance failure could be life-threatening or otherwise catastrophic.

11.2 Assembly Precaution

- 11.2.1 Please use the mounting hole on the module side in installing and do not bending or wrenching LCD in assembling. And please do not drop, bend or twist LCD module in handling.
- 11.2.2. Please design display housing in accordance with the following guide lines.
 - 11.2.2.1 Housing case must be destined carefully so as not to put stresses on LCD all sides and not to wrench module. The stresses may cause non-uniformity even if there is no non-uniformity statically.
 - 11.2.2.2 Keep sufficient clearance between LCD module back surface and housing when the LCD module is mounted. The clearance in the design is recommended taking into account the tolerance of LCD module thickness and mounting structure height on the housing.
- 11.2.3 Please do not push or scratch LCD panel surface with any-thing hard. And do not soil LCD panel surface by touching with bare hands.(Polarizer film, surface of LCD panel is easy to be flawed.)
- 11.2.4 Please do not press any parts on the rear side such as source IC, gate IC, and FPC during handling LCD module, If pressing rear part is unavoidable, handle the LCD module with care not to damage them.
- 11.2.5 Please wipe out LCD panel surface with absorbent cotton or soft cloth in case of it being soiled.
- 11.2.6 Please wipe out drops of adhesives like saliva and water on LCD panel surface immediately. They might damage to cause panel surface variation and color change.
- 11.2.7 Please do not take a LCD module to pieces and reconstruct it. Resolving and reconstructing modules may cause them not to work well.

11.3 Disassembling or Modification

Do not disassemble or modify the module. It may damage sensitive parts inside LCD module, and may cause scratches or dust on the display. Century does not warrant the module, if customers disassemble or modify the module.

11.4 Breakage of LCD Panel

- 11.4.1.If LCD panel is broken and liquid crystal spills out, do not ingest or inhale liquid crystal, and do not contact liquid crystal with skin.
- 11.4.2. If liquid crystal contacts mouth or eyes, rinse out with water immediately.
- 11.4.3. If liquid crystal contacts skin or cloths, wash it off immediately with alcohol and rinse thoroughly with water.
- 11.4.4. Handle carefully with chips of glass that may cause injury, when the glass is broken

11.5 Absolute Maximum Ratings and Power Protection Circuit

- 11.5.1. Do not exceed the absolute maximum rating values, such as the supply voltage variation, input voltage variation, variation in parts' parameters, environmental temperature, etc., otherwise LCD module may be damaged.
- 11.5.2. Please do not leave LCD module in the environment of high humidity and high temperature for a long time.
- 11.5.3. It's recommended to employ protection circuit for power supply.

11.6 Operation

- 11.6.1 Do not touch, push or rub the polarizer with anything harder than HB pencil lead.
- 11.6.2 Use fingerstalls of soft gloves in order to keep clean display quality, when persons handle the LCD module for incoming inspection or assembly.
- 11.6.3 When the surface is dusty, please wipe gently with absorbent cotton or other soft material.
- 11.6.4 Wipe off saliva or water drops as soon as possible. If saliva or water drops contact with polarizer for a long time, they may causes deformation or color fading.
- 11.6.5 When cleaning the adhesives, please use absorbent cotton wetted with a little petroleum benzine or other adequate solvent.

11.7 Static Electricity

- 11.7.1 Protection film must remove very slowly from the surface of LCD module to prevent from electrostatic occurrence.
- 11.7.2. Because LCD module use CMOS-IC on circuit board and TFT-LCD panel, it is very weak to electrostatic discharge. Please be careful with electrostatic discharge.
- 11.7.3 Persons who handle the module should be grounded through adequate methods.

11.8 Disposal

When disposing LCD module, obey the local environmental regulations.

11.9 Others

- 11.9.1 A strong incident light into LCD panel might cause display characteristics' changing inferior because of Polarizer film, color filter, and other materials becoming inferior. Please do not expose LCD module direct sunlight Land Strong UV rays.
- 11.9.2 Please pay attention to a panel side of LCD module not to contact with other materials in pressing it alone.
- 11.9.3 For the packaging box, please pay attention to the followings:
 - 11.9.3.1 Packaging box and inner case for LCD are designed to protect the LCDs from the damage or scratching during transportation. Please do not open except picking LCDs up from the box.
 - 11.9.3.2 Please do not pile them up more than 6 boxes(They are not designed so) And please do not turn over.
 - 11.9.3.3 Please handle packaging box with care not to give them sudden shock and vibrations. And also please do not throw them up.
 - 11.9.3.4 Packing box and inner case for LCDs are made of cardboard, So please pay attention not to get them wet(Such like keeping them in high humidity or wet place can occur getting them wet.)